

505228211X3W

TRACK PROJECTOR FC82 13,09W 3000K



LED projector for its installation in three-phase track. Leave exposed heatsink for a better dissipation of the heat. Black or silver anodized. Faceted reflector with high performance and different openings.

EFFECTIVE LIGHTING INFORMATION





FLUX	1349,79Lm
LM/W	103,12 lm/w
Consumption	13,09W
Opening angle	16°-24°-38

* Please ask, for other power or lighting flux.



LED FEATURES

Colour temperature	3000K
LED efficiency	153 Lm/W @TA=25°C
MacAdam Ellipse	3
Lifetime	50.000H @TA=25°C
Lighting flux maintenance	L80
LED deterioration	B10
CRI	80

FEATURES

	Three-phase track
	5 years guarantee
	Water tightness
	Mechanical resistor
	0,895Kg

ELECTRICAL INFORMATION

	230V/50Hz
	On/Off Power Supply
	Class I



RAL9003 (Text. White)

RAL9005 (Text. Black)



505228211B3W

505228211N3W

505228211X3S

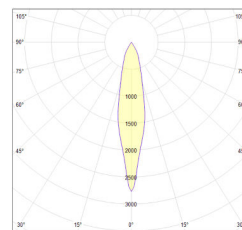

505228211X3N

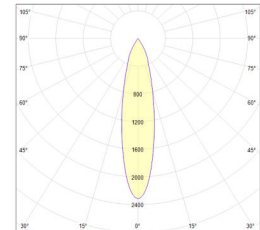

505228211X3F

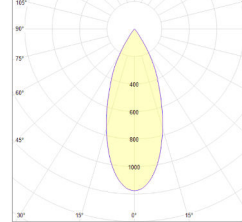

MEASUREMENTS

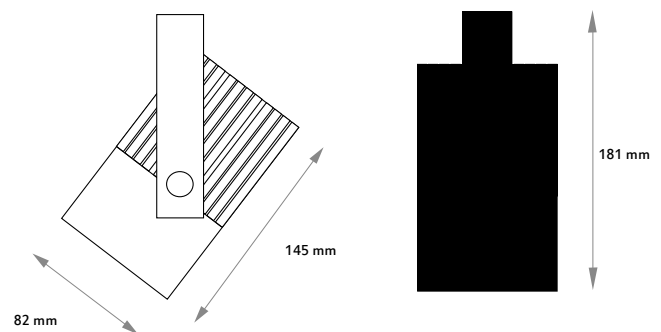

ACCESSORIES

Track XTS



Three-phase surface track 2 m. 50531CARS2MX
 Three-phase surface track 3 m. 50531CARS3MX
 Three-phase recessed track 2 m. 50531CARE2MX
 Three-phase recessed track 3 m. 50531CARE3MX

Supply XTS



SUPPLY XTS 11 50531ALIMEDIX
 SUPPLY XTS 12 50531ALIMEDDX

External union XTS



External union 50531UNIONEX

Inner union XTS



Inner union 50531UNIONIN

Adjustable elbow



Left joining elbow piece 50531CODOIZX
 Right joining elbow piece 50531CODODRX

Endcap



Endcap 50531TAPFINX

Union in T



Union piece in "T" 50531UNIONTX

Articulated elbow



Flexible joining elbow piece 50531CODOFLX

Suspension kit



Suspension kit for track 50531SUSPE3X

Cross union



Joining piece in cross 50531UNIONCX